

AMPAMP INCORPORATED
HARRISBURG, PA 17105AMP* INSERTION TOOLS
59803-1 AND 59804-1
FOR MASS TERMINATION ASSEMBLY (MTA)
CONNECTORS

REDUCED FOR PACKAGING

IS 7907CUSTOMER HOTLINE
1 800 722-1111RELEASED
12-16-88

Fig. 1

1. INTRODUCTION

This instruction sheet covers the use of AMP Insertion Tools 59803-1 and 59804-1 designed to terminate .100-in. and .156-in. centerline MTA connectors. Read these instructions thoroughly before using the tools to ensure correct termination of the wire.

NOTE

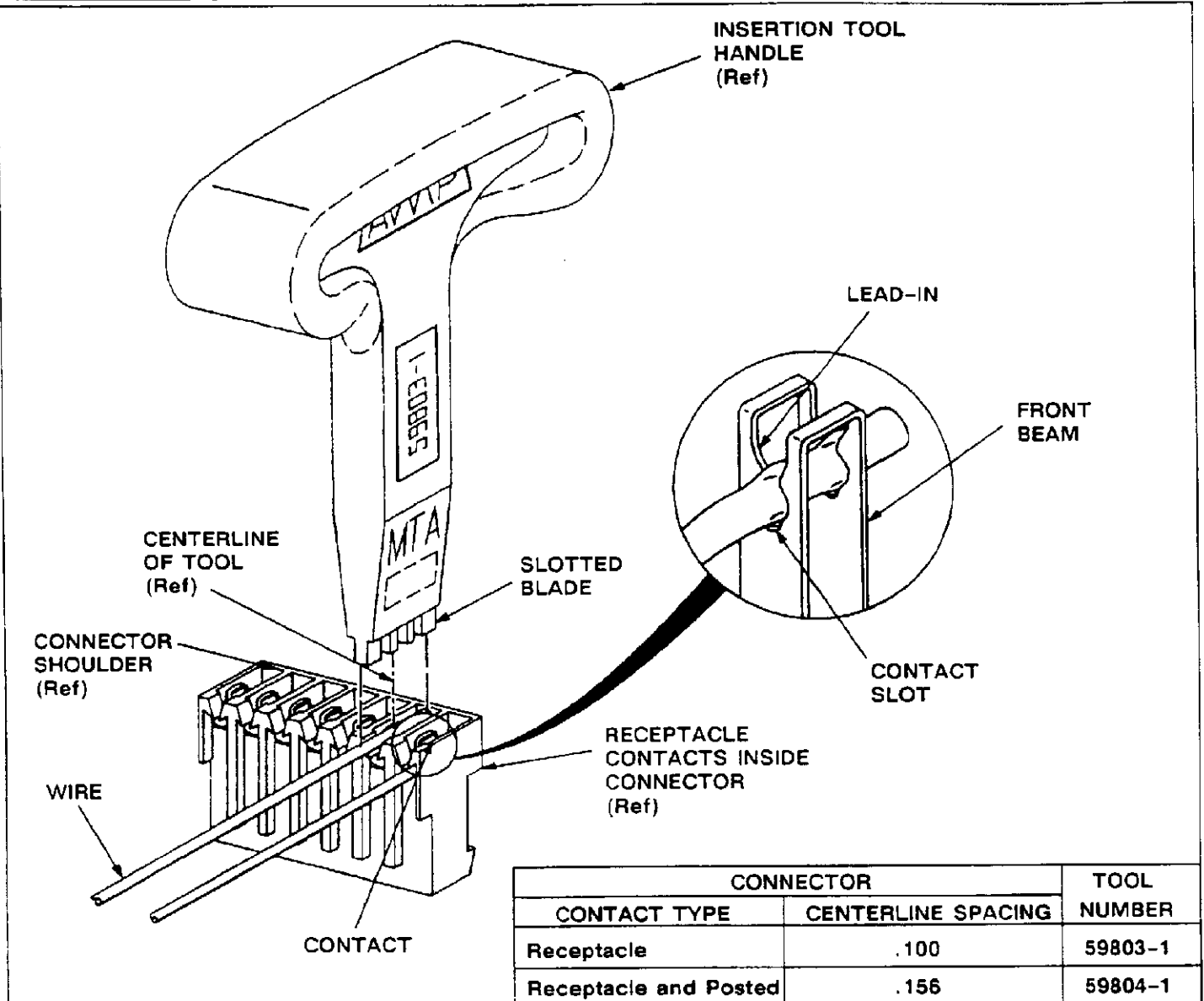
All dimensions on this instruction sheet are in inches.

2. DESCRIPTION (Figure 1)

The T-handle wire insertion tool is equipped with a slotted blade design which is used to insert the wire into the MTA connector. The blade is designed to fit into the connector slot to terminate the wire using the Displacement Terminating Technique.

This technique requires inserting an unstripped wire into a slotted contact beam to form a reliable electrical connection between the conductor and contact.

The tool number is stamped on the tool side and the AMP marking is molded on both sides. Insertion tool 59803-1 is designed for connectors with contacts on .100-in. centers (MTA 100), and insertion tool 59804-1 is designed for connectors with .156-in centers (MTA 156).

3. INSERTION PROCEDURES (Figure 2)

1. Place the connector block on a flat surface or suitable support to prevent possible rocking when inserting the wire.
2. Position wire over the contact in the MTA connector. Make sure the end of the wire does

not extend over the shoulder of the connector. Start the wire into contact with finger.

3. Place appropriate tool on wire over contact so that the centerline of the tool matches the contact. The tool must be positioned as shown in Figure 2.

4. Holding the tool handle perpendicular to the contact, apply a constant, direct pressure until the wire is terminated with the contact. Exert pressure in such a manner as to avoid contact damage.

5. Remove tool and inspect contact for proper wire insertion. If necessary, repeat the operation.

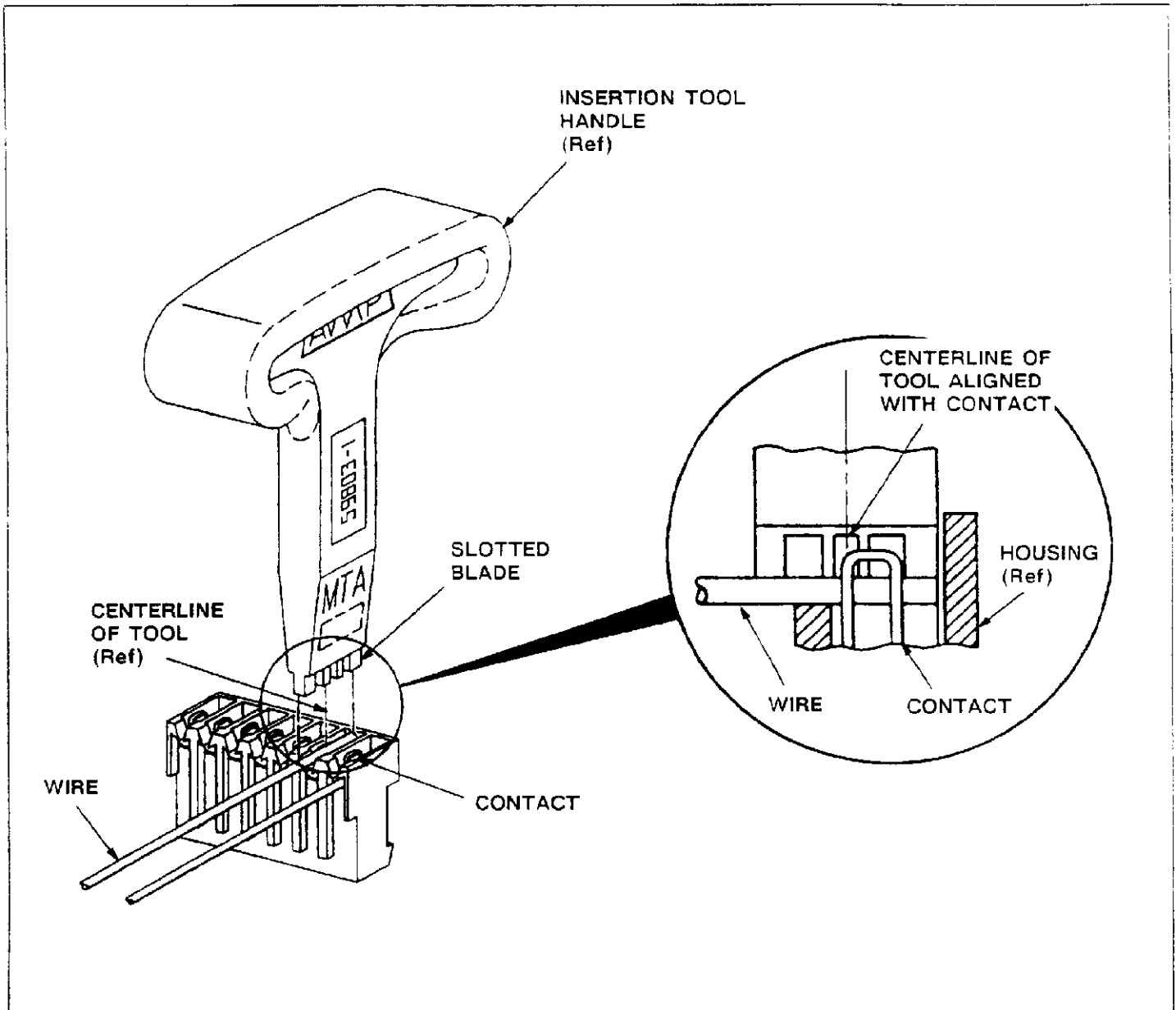
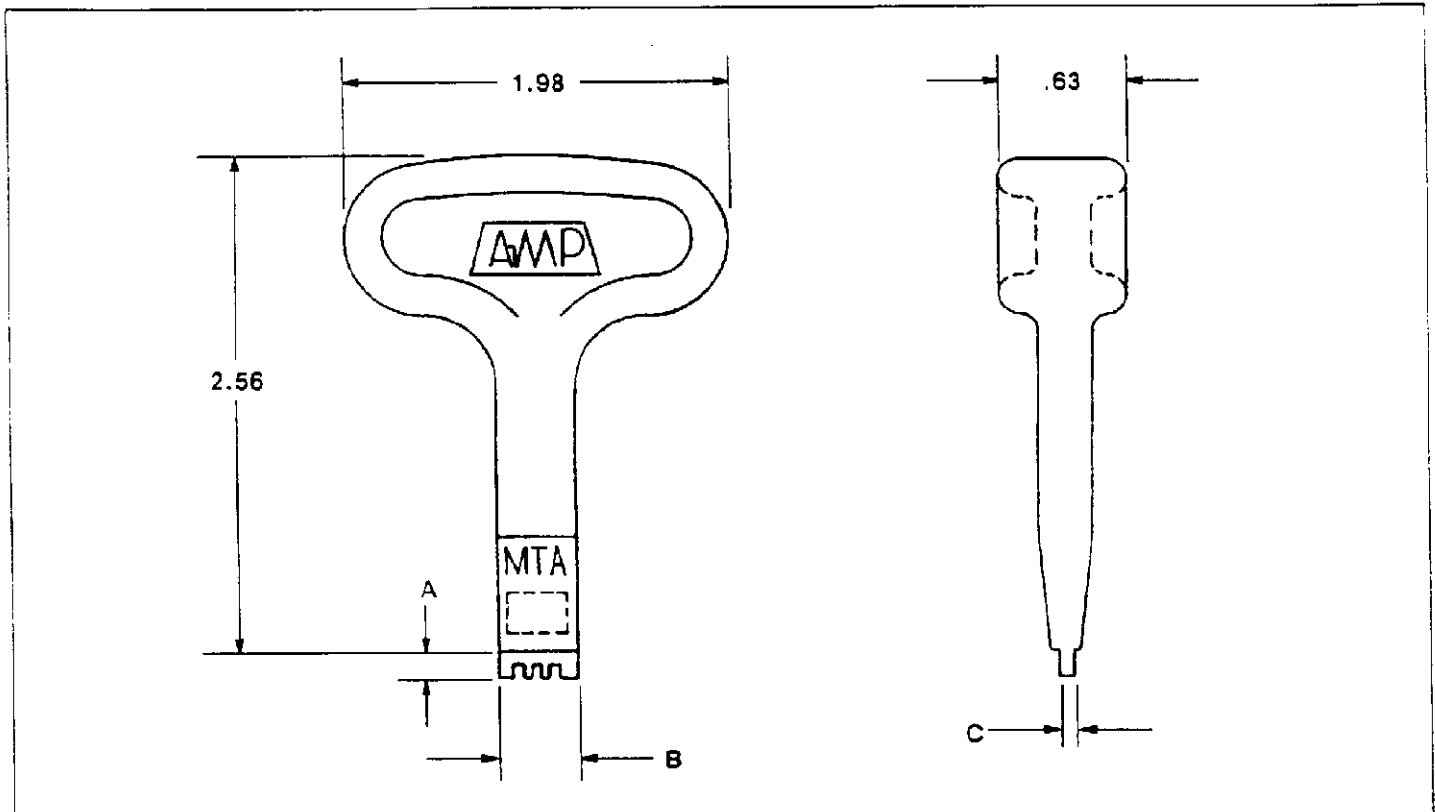

Fig. 2



TOOL NUMBER	DIMENSIONS			PRODUCT DESIGNED FOR
	A	B	C	
59803-1	.105	.280	.040	MTA 100 Connector
59804-1	.120	.375	.050	MTA 156 Connector

Fig. 3

4. TOOL INSPECTION

The insertion tools listed on this instruction sheet should be inspected with the information provided in Figure 3. We recommend that you inspect the tools immediately upon arrival at your facility, and at regularly scheduled intervals, to ensure that the tools have not been damaged during handling.

Additional tools can be purchased from:

AMP Incorporated
 P.O. Box 3608
 Harrisburg, PA 17105-3608

or a wholly owned subsidiary of AMP Incorporated.